



Domitienne is a rectangular section pole (250 x 150 mm) and offers heights ranging from 4 to 8 m. Its lighting arm, articulated with a hinge for the Flex version, tilts from 0 to 30° to draw a broken line with a more or less open angle. Made of extruded aluminum, the luminaire accommodates one or two modules of up to 96 LEDs protected by tempered screen-printed glass. Available in 1 or 2 light versions, it exists in wall or pole mounted versions as well as in different heights. This variety of configurations allows the creation of design bouquets.



DOMITIENNE

DESIGN | DOMITIENNE



- ▶ Hinged door.
- ▶ Holds 1 or 2 modules, up to 96 LED.
- ▶ Fixed or Flex version with articulated hinge.

*Regulation specific to France: Decree of 27/12/2018 relating to the prevention, reduction and limitation of light nuisance: product configuration to be defined according to the nature of the project.

11/04/2022 - All informations are subject to change without notice.

w w w . r a g n i . c o m



DOMITIENNE

LUMINAIRE'S SPECIFICATIONS

Luminaire's body & Electrical Housing

Materials

Pole: Galvanised steel
Luminaire: Aluminium

DESIGN | DOMITIENNE

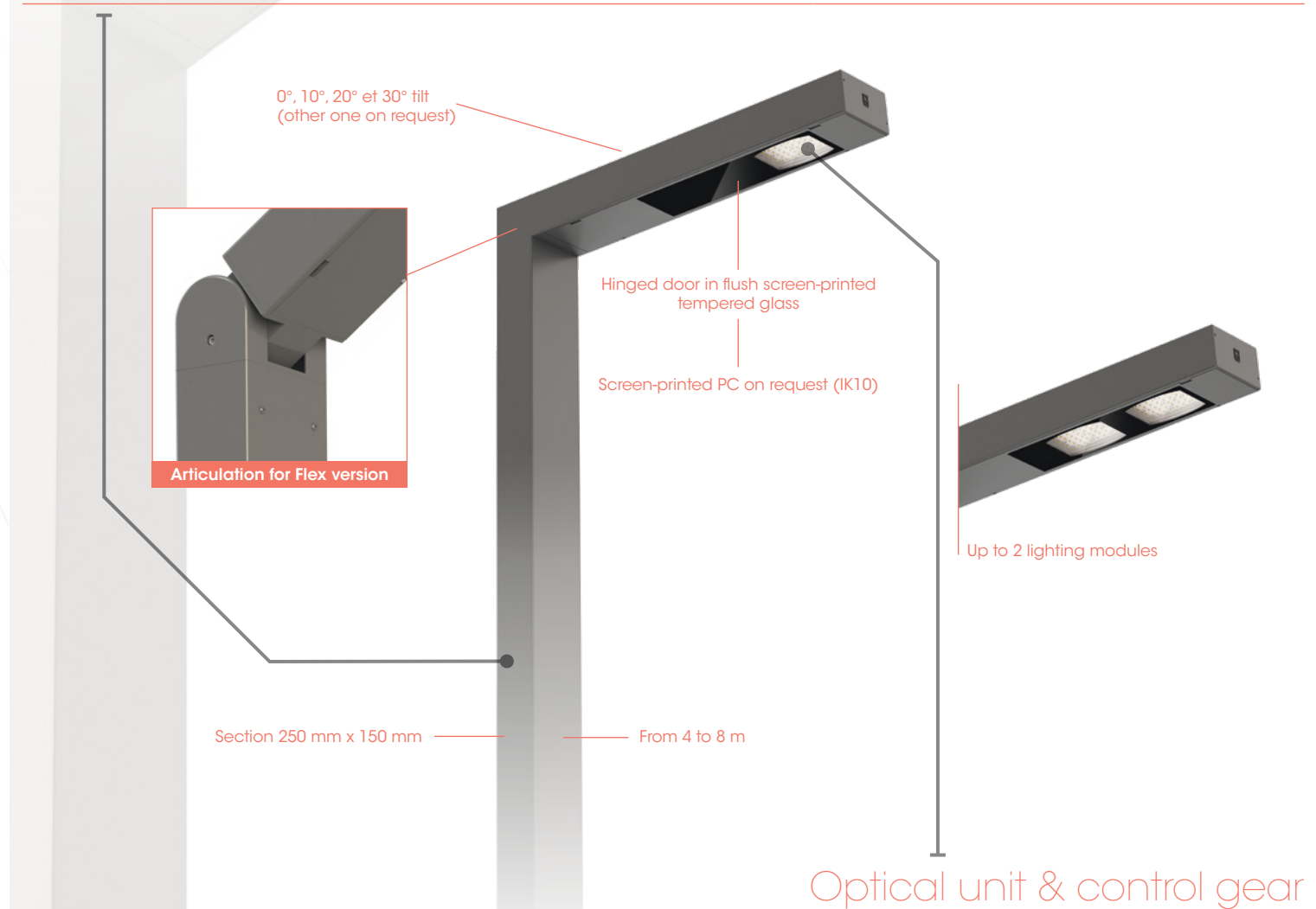

EVO2 LED module from 8 to 48 LED - From 1000 to 10300 lm - Up to 20600 lm with 2 LED module (see EVO2 attached data sheet for details on power, light intensities and available photometries). Integrated smart driver (control, automatic adjustment, CLO, graduation via voltage variation or DALI). ULR 0% (ULR: Upward Light Ratio).

Materials	Tempered glass (PC on request)
Electric class	I and II
Protection index	IP66
Shock resistance	IK08 (IK10 on request)

Operating temperature: -40°C to +35°C (up to +50° under conditions).

11/04/2022 - All informations are subject to change without notice.



Two lights



Surface mounted



DOMITIENNE FLEX



Outreach	800 mm	1200 mm	1500 mm
Weight	11 kg	17 kg	19 kg

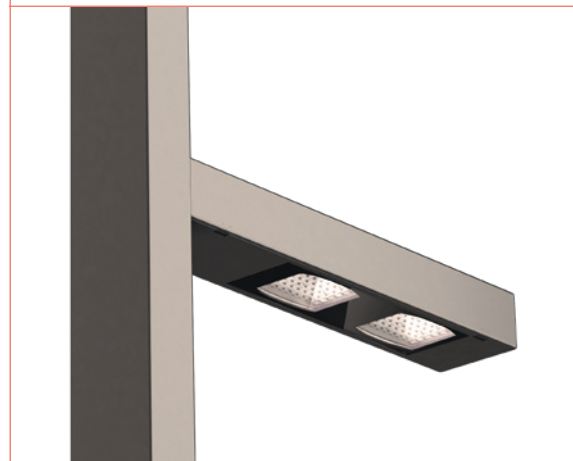

11/04/2022 - All informations are subject to change without notice.

DOMITIENNE

GENERAL SPECIFICATIONS

Heights & outreaches

Available heights: 4000 mm, 5000 mm, 6000 mm, 7000 mm, 8000 mm

Available outreaches: 800 mm, 1200 mm, 1500 mm

Mechanical specifications (EN 40)

		Guyana: 17 m/s	Area 1: 22 m/s	Area 2: 24 m/s	Area 3: 26 m/s	Area 4: 28 m/s	Martinique : 32 m/s	Reunion: 34 m/s	Guadeloupe : 36 m/s
4 m	Mf* (daN.m)	163	273	324	381	441	576	650	729
	T* (daN)	69	115	136	160	185	242	273	306
	Side of concrete block (m)	0.4	0.4	0.4	0.4	0.4	0.5	0.5	0.5
	Height of concrete block (m)	0.5	0.6	0.6	0.6	0.7	0.7	0.8	0.8
5 m	Mf* (daN.m)	247	413	491	577	669	873	986	1105
	T* (daN)	86	144	171	200	232	303	342	383
	Side of concrete block (m)	0.4	0.4	0.4	0.5	0.5	0.5	0.5	0.6
	Height of concrete block (m)	0.5	0.7	0.7	0.7	0.8	0.9	0.9	0.9
6 m	Mf* (daN.m)	361	605	719	844	979	1278	1443	1618
	T* (daN)	107	179	213	250	290	378	427	479
	Side of concrete block (m)	0.4	0.5	0.5	0.5	0.5	0.6	0.6	0.6
	Height of concrete block (m)	0.6	0.7	0.8	0.9	0.9	1	1.1	1.1
7 m	Mf* (daN.m)	510	853	1016	1192	1382	1805	2038	2284
	T* (daN)	132	220	262	307	356	465	525	589
	Side of concrete block (m)	0.5	0.5	0.5	0.6	0.6	0.7	0.8	0.8
	Height of concrete block (m)	0.7	0.9	1	1	1	1.1	1.1	1.2
8 m	Mf* (daN.m)	681	1141	1358	1593	1848	2413	2724	3054
	T* (daN)	156	261	310	364	422	551	622	697
	Side of concrete block (m)	0.5	0.5	0.6	0.6	0.7	0.8	0.8	0.9
	Height of concrete block (m)	0.8	1	1	1.1	1.1	1.2	1.4	1.3

*Mf: Bending moment. *T: Shear force. Calculations and technical information are provided for reference only. The manufacturer cannot be held responsible. The technical or aesthetic specifications are subject to change without notice.

11/04/2022 - All informations are subject to change without notice.

Dimensions (mm)

Wall-mounted and against a pole versions

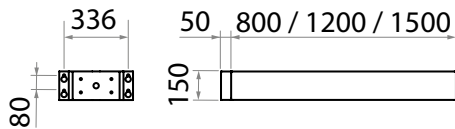

4 anchor bolts M18/Ø20x400 (not supplied)

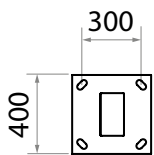

Height 8m, wind areas 36 and 34 m/s:
4 anchor bolts M24/Ø25x600 (not supplied)

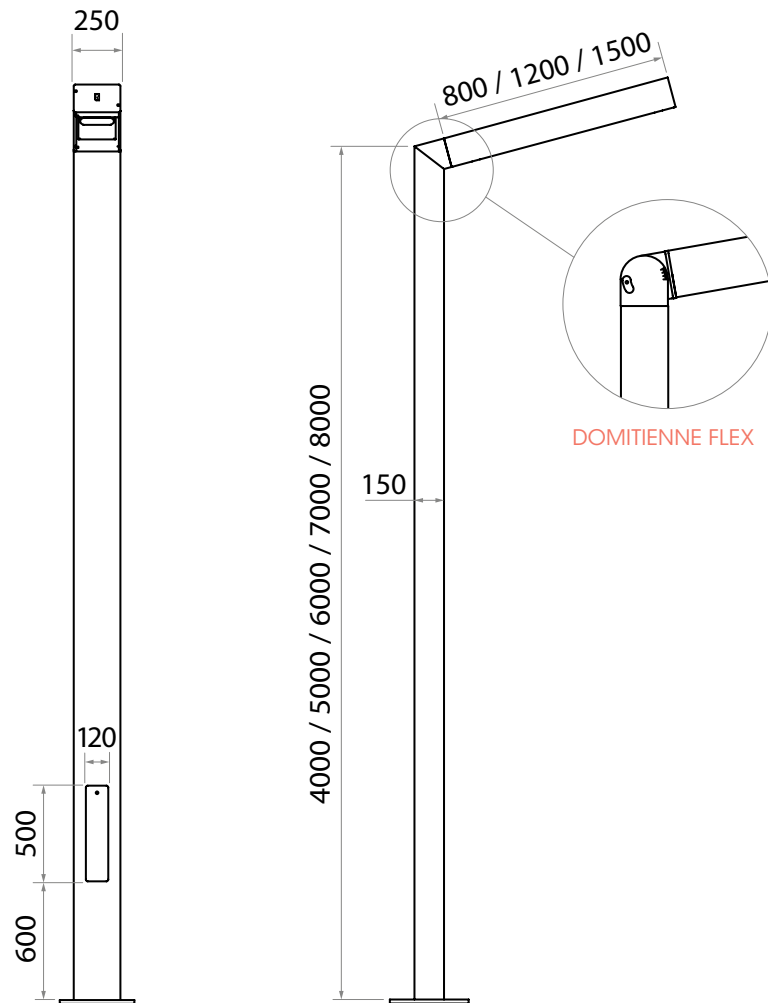

Options

- Surge protector.
- Backlight control.
- NTC sensor.
- Presence detector.
- Screen printed PC (IK10).
- DOMITIENNE FLEX.

Ecodesign

Luminaire designed in compliance with the environmental criteria of energy efficiency, recyclability and interoperability.

Associate member of the Zhaga consortium, Ragni integrates electronic elements in this product that comply with the Zhaga standard, which ensures its scalability and interoperability.

Member of the Global Compact since 2018, Ragni is committed to working towards the 17 Sustainable Development Goals (SDG 11, 12, 13, 15).

Luminaire guaranteed free of hazardous substances.

Luminaire eligible for the energy savings certificate.

Luminaire compliant with the decree of 27/12/2018 on the prevention, reduction and limitation of light pollution: product configuration to be defined according to the nature of the project.



Applicable standards

IEC/EN 60598-1 / IEC/EN 60598-2-3 / NF EN 60529 / NF EN 62262 / IEC/EN 55015 / IEC/EN 61547 / IEC/EN 61000-3.2 / IEC/EN 61000-3.3 / IEC/EN 62493 / IEC/EN 62031 / IEC/EN 62471 / IEC/EN 61347-1 / IEC/EN 61347-2-13 / NF EN 13201-3 / NF EN 13201-4 / EN 13032-1+A1 & EN 13032-4 / LM79 / NF EN 12981

11/04/2022 - All informations are subject to change without notice.





Sets proposals

DESIGN | DOMITIENNE

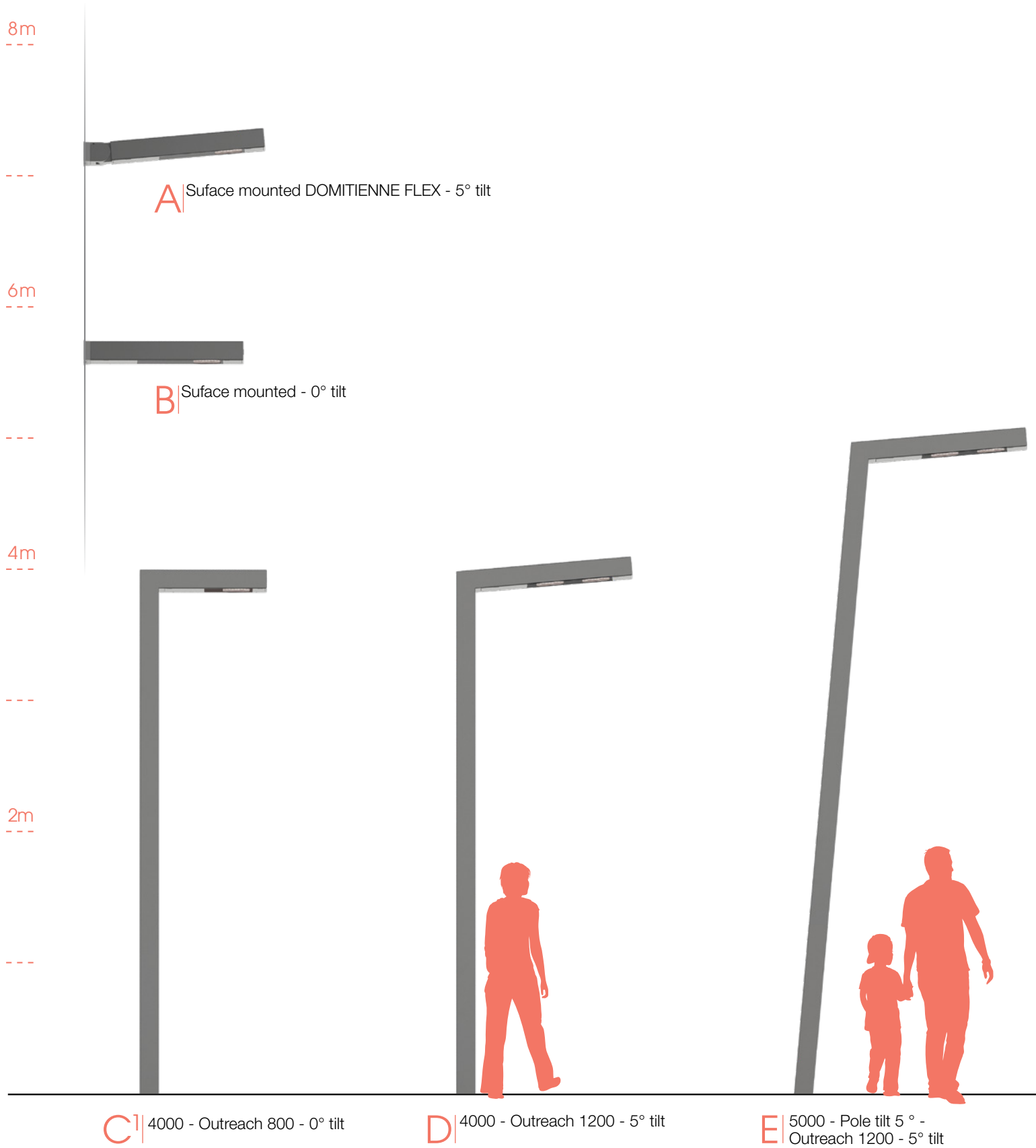

DOMITIENNE

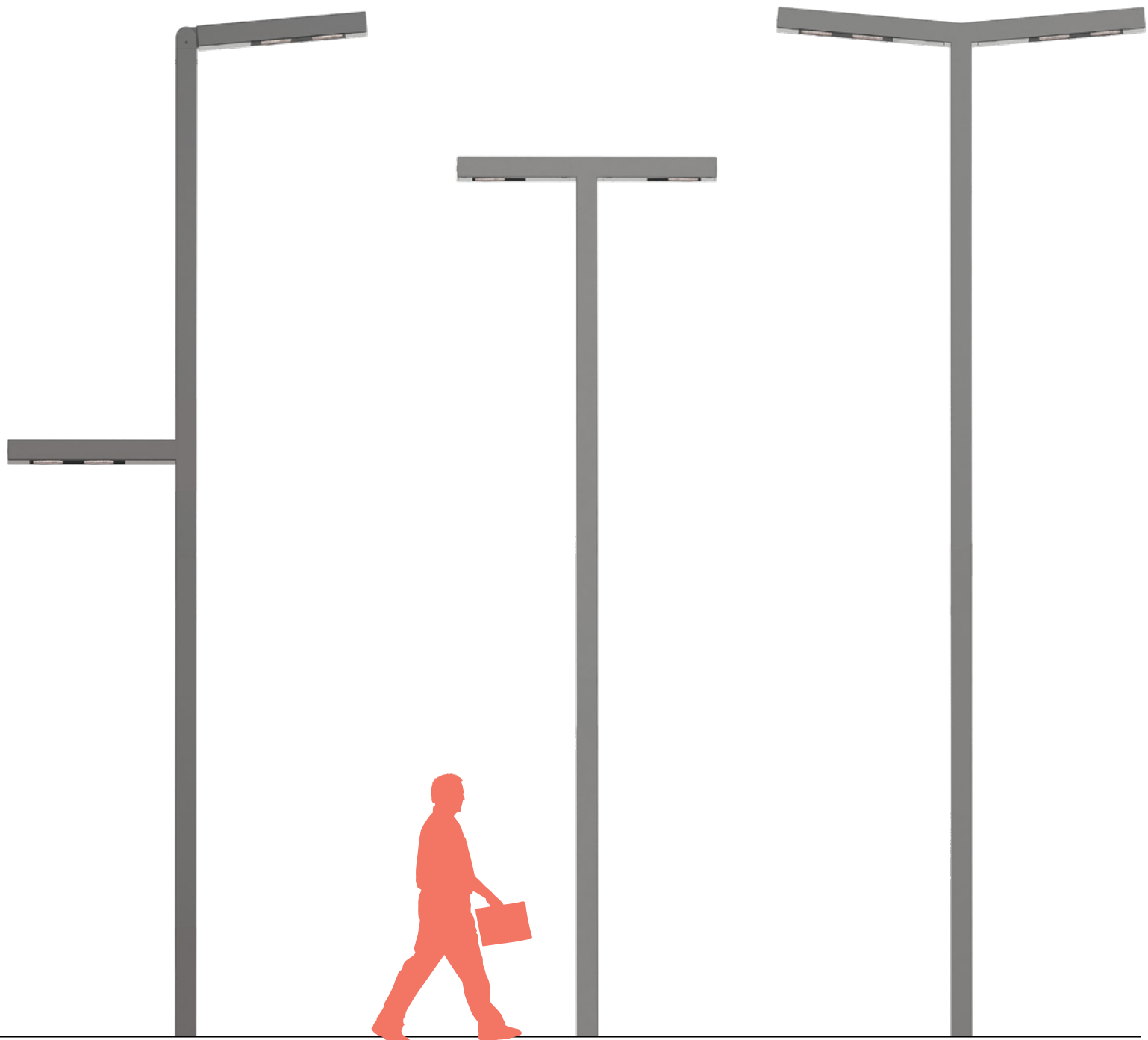

F | DOMITIENNE FLEX 7000 -
Outreach 1200 - 5° tilt - Outreach 1200
surface mounted at 4 m - 0° tilt

G | 6000 - 2 lights - Outreach 1200

H | 6000 - 2 lights - Outreach
1200 - 5° tilt

DESIGN | DOMITIENNE